



INSTALLATION INSTRUCTIONS FOR UNION TYPE PX789 PX784

UNION TYPE PX FOR CONNECTING CONDUITS TO ENCLOSURES OR CONDUITS TO EACH OTHER USING BARRIER COMPOUND IN EXPLOSIVE ATMOSPHERES.

INCORPORATING EU DECLARATION OF CONFORMITY TO DIRECTIVE [2014/34/EU]



TECHNICAL DATA

ADAPTOR TYPE : PX789 PX784
INGRESS PROTECTION : IP66 when used with CMP sealing accessories
PROCESS CONTROL SYSTEM : ISO 9001
 : ISO/IEC 80079-34:2011

EXPLOSIVE ATMOSPHERES CLASSIFICATION

ATEX CERTIFICATION No : CML 18ATEX1329U
ATEX CERTIFICATION CODE : II 2G 1D Ex db IIC Gb, Ex eb IIC Gb, Ex ta IIIC Da IP6X
 : IM2 Ex db I Mb / Ex eb I Mb

IECEX CERTIFICATION No : IECEX CML 18.0186U
IECEX CERTIFICATION CODE : Ex db IIC Gb, Ex eb IIC Gb, Ex ta IIIC Da IP6X, Ex db I Mb, Ex eb I Mb
cCSAus CERTIFICATION No : 1055233
CODE OF PROTECTION : Class I Div 1 & 2, Groups A,B,C,D ; Class I Zone 1, AEx de II; Ex de II

INSTALLATION INSTRUCTIONS

- Installation should only be performed by a competent person using the correct tools. Spanners should be used for tightening. Read all instructions before beginning installation.
- The interface between a cable entry device and its associated enclosure / cable entry will require additional sealing to achieve ingress protection (IP) ratings higher than IP54. The minimum protection level is IP54 for explosive gas atmospheres and IP6X for explosive dust atmospheres. Parallel threads (and tapered threads when using a non-threaded entry) require a CMP sealing washer or integral O-ring face seal (where available) to maintain IP66, 67 and 68 (when applicable). It is the installer's responsibility to ensure the IP rating is maintained at the interface.
 Note: When fitted to a threaded entry, all tapered threads will automatically provide an ingress protection rating of IP68.
- A CMP earth tag should be used when it is necessary to provide an earth bond connection. CMP earth tags have been independently tested to comply with Category B rating specified in IEC 62444 (there are no ratings stated in IEC 60079-0). Ratings are shown in the associated table. CMP earth tags slip over the cable gland or accessory entry thread from inside/outside the enclosure and must be secured with a locknut (if fitted internally).

CMP Earth Tag Size	Short Circuit Ratings Symmetrical Fault Current (kA) for 1 second
20	3.06
25	4.06
32	5.40
40	7.20
50	10.40
63	10.40
75	10.40

SPECIAL CONDITIONS FOR SAFE USE

Only one union is to be used with any single cable entry on the associated equipment.

ACCESSORIES

The following accessories are available from CMP Products, as optional extras, to assist with fixing, sealing and earthing:
 Locknut | Earth Tag | Serrated Washer | Entry Thread (I.P.) Sealing Washer

METRIC		NPT				Diameter over Cores	Max. number of Cores	Max. Protusion Length	Max. Overhang Length	Across Flats Hex	Across Corners Ø	Installation Torque (Nm)		
Ordering Reference (Brass, Metric)	Male Forward Thread Size	Minimum Thread Length	Female Rear Thread Size	Ordering Reference (Brass, NPT)	Male Forward NPT Thread Size								Minimum NPT Thread Length (in)	Female Rear Thread Size
PX789DM2M2	M20 X 1.5	15.0	M20 X 1.5	PX789DT1T1	1/2"	0.79	1/2"	12.6	21	62.9	63.8	46.0	50.6	7
PX789DM3M3	M25 X 1.5	15.0	M25 X 1.5	PX789DT2T2	3/4"	0.80	3/4"	17.5	30	70.6	69.5	50.0	55.0	10
PX789DM4M4	M32 X 1.5	15.0	M32 X 1.5	PX789DT3T3	1"	0.98	1"	23.6	38	75.7	78.0	60.0	66.0	15
PX789DM5M5	M40 X 1.5	15.0	M40 X 1.5	PX789DT4T4	1-1/4"	1.01	1-1/4"	30.0	59	83.7	84.8	65.0	71.5	25
PX789DM6M6	M50 X 1.5	15.0	M50 X 1.5	PX789DT5T5	1-1/2"	1.03	1-1/2"	41.0	115	95.9	96.3	75.0	82.5	30
PX789DM7M7	M63 X 1.5	15.0	M63 X 1.5	PX789DT6T6	2"	1.06	2"	53.7	115	108.8	115.1	90.2	99.2	45

All dimensions shown are in millimetres unless otherwise stated
 For material options please add the following suffix to the Ordering Reference: Brass (no suffix required), Nickel Plated Brass "S", 316 Grade Stainless Steel "4", Copper Free Aluminium "1"

METRIC		NPT				Diameter over Cores	Max. number of Cores	Max. Protusion Length	Max. Overhang Length	Across Flats Hex	Across Corners Ø	Installation Torque (Nm)		
Ordering Reference (Brass, Metric)	Male Forward Thread Size	Minimum Thread Length	Female Rear Thread Size	Ordering Reference (Brass, NPT)	Male Forward NPT Thread Size								Minimum NPT Thread Length (in)	Female Rear Thread Size
PX784DM2M2	M20 X 1.5	15.0	M20 X 1.5	PX784DT1T1	1/2"	0.79	1/2"	12.6	21	60.6	55.8	46.0	50.6	7
PX784DM3M3	M25 X 1.5	15.0	M25 X 1.5	PX784DT2T2	3/4"	0.80	3/4"	17.5	30	65.9	61.2	50.0	55.0	10
PX784DM4M4	M32 X 1.5	15.0	M32 X 1.5	PX784DT3T3	1"	0.98	1"	23.6	38	69.5	70.2	60.0	66.0	15
PX784DM5M5	M40 X 1.5	15.0	M40 X 1.5	PX784DT4T4	1-1/4"	1.01	1-1/4"	30.0	59	74.9	76.4	65.0	71.5	25
PX784DM6M6	M50 X 1.5	15.0	M50 X 1.5	PX784DT5T5	1-1/2"	1.03	1-1/2"	41.0	115	93.5	88.0	75.0	82.5	30
PX784DM7M7	M63 X 1.5	15.0	M63 X 1.5	PX784DT6T6	2"	1.06	2"	53.7	115	102.7	103.4	90.2	99.2	45

All dimensions shown are in millimetres unless otherwise stated
 For material options please add the following suffix to the Ordering Reference: Brass (no suffix required), Nickel Plated Brass "S", 316 Grade Stainless Steel "4", Copper Free Aluminium "1"

CMP Products Limited on its sole responsibility declares that the equipment referred to herein conforms to the requirements of the ATEX Directive 2014/34/EU and the following standards: EN 60079-0:2018, EN 60079-1:2014, EN 60079-7:2015, EN 60079-31:2014

David Willcock - Certification Engineer (Authorised Person)
 CMP Products Limited, Cramlington, NE23 1WH, UK
 15 April 2019



Glasshouse Street • St. Peters • Newcastle upon Tyne • NE6 1BS
 Tel: +44 191 265 7411 • Fax: +44 1670 715 646
 E-Mail: customerservices@cmp-products.co.uk • Web: www.cmp-products.com

FI633		
Certificate	Revision	Date
IFS	4	05/19
ATEX / IECEX	1	04/19
CSA / cCSAus	-	-

INSTALLATION INSTRUCTIONS FOR CMP CABLE GLAND TYPES PX789 PX784

UNION COMPONENTS

- 1. Entry Item
- 2. Serrated Flamepath
- 3. Nut
- 4. 90° (or 45°) Conduit Connector
- 5. Washer
- 6. Compound Tube

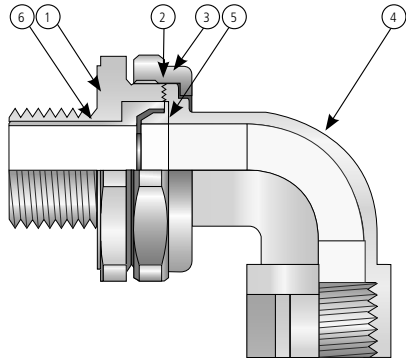

PLEASE READ ALL INSTRUCTIONS CAREFULLY BEFORE BEGINNING THE INSTALLATION

1. Slacken and remove the nut (3) to disassemble the union.

2. Prepare the cable by removing the outer sheath from the cores so that they are exposed within the Compound Tube when finally assembled.

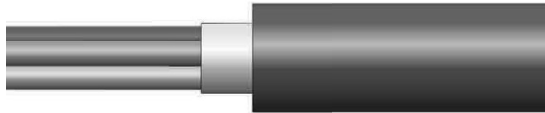

3. Feed the cables/cores through the conduit connector (4), nut (3) and washer (5), tighten the conduit connector onto the conduit.

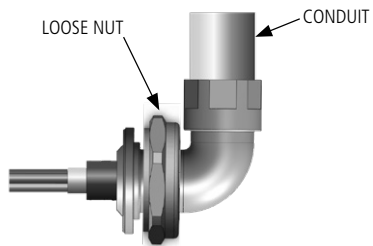

4. Wearing the protective gloves supplied, mix all of the two-part epoxy compound until it is pliable and an even colour is achieved (Min. mixing temperature 10° / 50° F)

5. Separate the cable cores and apply the compound to the crutch of the cable for a distance of about 6mm and pack into place. If the cable has individual or overall foil screens then these should be removed.

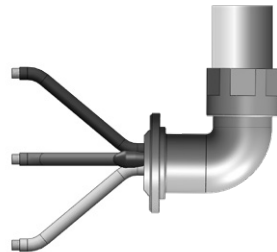

If a drain wire is present then it should be sleeved with some heat shrink tubing which is pushed into the compound before shrinking with the application of some heat. If braid screens have been twisted together they should be treated as a drain wire and sleeved.

6. Bring the cores together again and pack more compound around them to a length and diameter sufficient to fill the Compound Tube (6) (ensuring compound is packed between each of the cable cores) before ending in a taper.

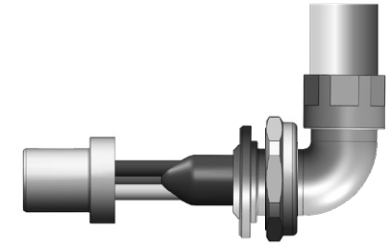

7. Pass the Compound Tube (6) over the conductors until the stepped end is fully located with the Washer (5). Pack more compound into place until the Compound Tube is fully fitted and trim off any excess.

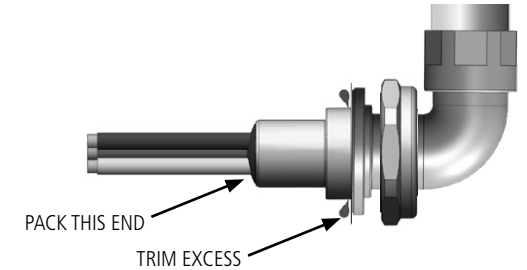

8. Attach the Entry Item (1) by screwing it into place, making sure the compound is not disturbed, and loosely tighten the Nut (3). Leave until the compound has cured.

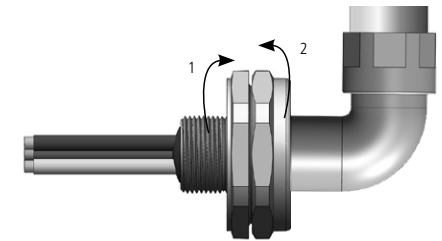

9. When the compound has cured the Entry Item (1) should be removed from the assembly and fully tightened into the apparatus. The Union can then be refitted to it and the Nut (3) fully tightened to complete the installation.

